

Operating Instructions

COMBIPHON



Operating Instructions

COMBIPHON®

07.02.2008 – V 1.X – 103411 – en

1	System overview	1
2	Intended usage and principle of operation.....	3
3	COMBIPHON system	5
3.1	Generator G5	6
3.2	Loading the Battery	7
3.3	Generator G5 – Radio.....	7
3.4	AC/DC adapter L.....	8
3.5	Car cable L.....	9
4	Knocker.....	10
4.1	Knocker – Starting and operating	11
4.2	Working with the Knocker.....	11
4.3	Maintaining the Knocker.....	12
5	Stopper.....	13
5.1	Stopper – Starting and operating	14
5.2	Working with the Stopper	15
5.3	Maintaining the Stopper	16
5.4	Important notes on use and care	18
6	Troubleshooting.....	19
6.1	General	19
6.2	Knocker	19
6.3	Stopper.....	20
7	Technical data.....	21
7.1	Generator G5 and G5 Radio	21
7.2	AC/DC adapter L.....	21
7.3	Knocker	22
7.4	Stopper.....	22
7.5	Radio remote control (Option).....	22

Appendix	23
Modification History Software.....	23
Declaration of Conformity	24
Index.....	25

1 System overview

COMBIPHON system

- 1 Foam insert for accessories
- 2 AC/DC adapter L
- 3 Car cable L
- 4 Knocker
- 5 Remote control
- 6 Generator G5 with control panel
- 7 Connection for an external power source
- 8 Connection for oscillator

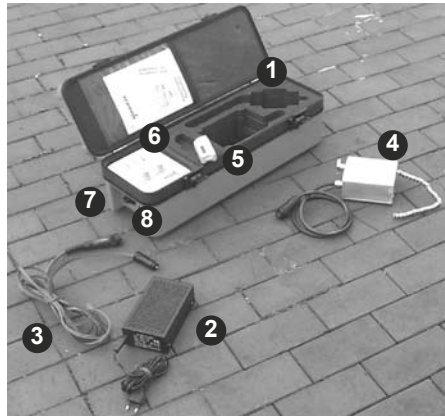

Picture 1: COMBIPHON system

- 9 Stopper
- 10 Standpipe



Picture 2: Stopper and accessories

Generators G5 control panel

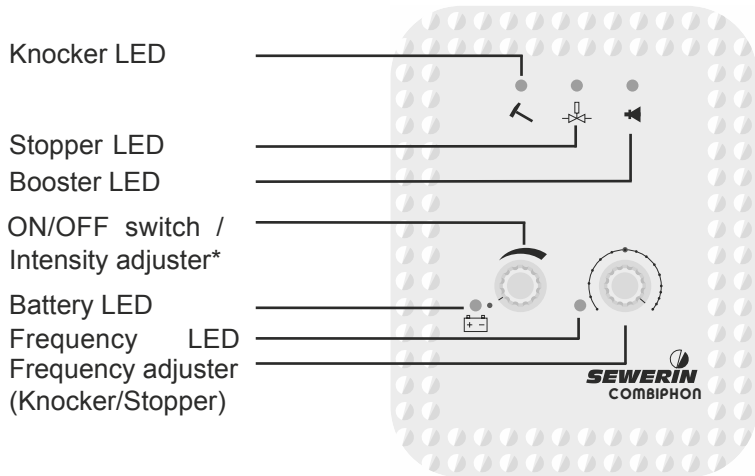

Picture 3: Control panel

*

Intensity adjuster for Knocker only. The intensity of the Stopper is set via a valve.

2 Intended usage and principle of operation

Plastic pipes cannot be located using traditional electromagnetic methods as they are not electrically conductive.

The acoustic method uses a different principle for locating pipes: The pipes propagate mechanical oscillations better than the surrounding earth. If the pipe is subject to the right oscillations, they are transferred along the pipe and via the earth to the earth's surface. These oscillations can be detected according to the principle of electro-acoustic leak detection by a ground microphone and receiver equipped with headphones. The **AQUAPHON** System, for example, is ideally suited for this task.

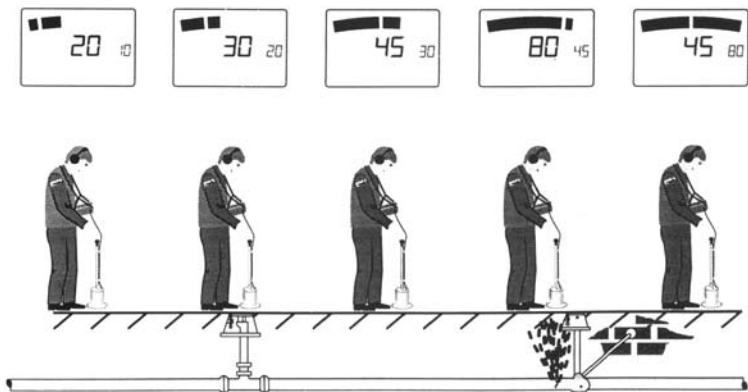

Picture 4: Acoustic leak detection

Similar to the acoustic detection of water leakages, the pipeline is generally located where the highest intensity is detected. This is how fibre cement and metal pipes are principally detected.

The **COMBIPHON** system consists of the Generator G5 central control unit, the AC/DC adapter L, a car cable L as well as various oscillators (Knocker, Stopper).

The Knocker places the service pipes (water or gas) under oscillation by knocking on the outside of the pipeline like an electric hammer. Gas or airfilled pipes are sometimes difficult to detect since the conductive water column is missing.

2 Intended usage and principle of operation

The Stopper creates a pressure wave by rapidly opening and closing the flow to the pipe. Main pipes (water) require more energy to be placed under oscillation. The water column is set in motion by extracting water from a hydrant. A special shutoff element known as the Stopper slows down the motion of the water column at regular intervals. The resulting pressure waves propagate along the pipeline and can be detected over long distances. The intensity of the generated pressure wave can be adjusted via the valve on the device.

3 COMBIPHON system

The following describes the various system components as well as their intended usage.

The described system elements are laid out in the carrying case so that they can be easily removed for use and stowed away as well as operated from the case itself.





Adhesive label showing software version (e.g., 1.1)*



Picture 5: Generator G5 and its components in the carrying case



* see note on page 23



3.1 Generator G5

The Generator G5 is located on the left of the carrying case. It is an integral part of the carrying case and cannot be removed. The control elements of the generator are used to set the frequency (see Picture 3) and the intensity of the impulse used for detection. In addition, the control panel is fitted with a number of LEDs, which indicate the following statuses:

-  ● Knocker LED LED is lit when the Knocker is connected to the system and switched on.

-  ● Stopper LED
 LED is lit when the Stopper is connected to the system and switched on.

-  ● Booster LED without function

-  ● Battery LED This LED indicates the following operating states:

green (on):	normal operation
red, flashing:	under voltage
green, flashing:	charging
green, double flashing:	buffering

3.2 Loading the Battery



Note:

To maintain the device in continuous operation, it should always be connected to an external power source (e.g., via the car cable L).

Detailed information

In buffer mode the battery is not charged, only monitored. The battery is charged

- once per week,
- when the battery voltage falls below 12 V or
- when the Generator G5, e.g., after use, remains connected to an external power source.

Charging is complete when the battery voltage has reached 14.5 V.

If the battery voltage falls below 10 V, the Generator G5 switches to “standby mode” (all LEDs extinguish; the quiescent current equals < 7 mA).

3.3 Generator G5 – Radio

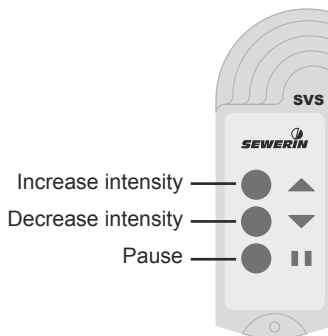

The **COMBIPHON** Generator G5 radio is to a great extent identical to the standard version described in Chapter 3.1.

The only difference is the supplied remote control and the corresponding receiver element on the generator.

With the Stopper, only the “Pause” key has a function.

Picture 6: Remote control

The remote control allows the intensity (Knocker) to be adjusted. It is not possible to adjust the intensity beyond that defined by the position of the adjuster on the generator. Therefore, to achieve the maximum intensity at the Knocker via the remote control, the intensity adjuster must also be rotated fully clockwise.

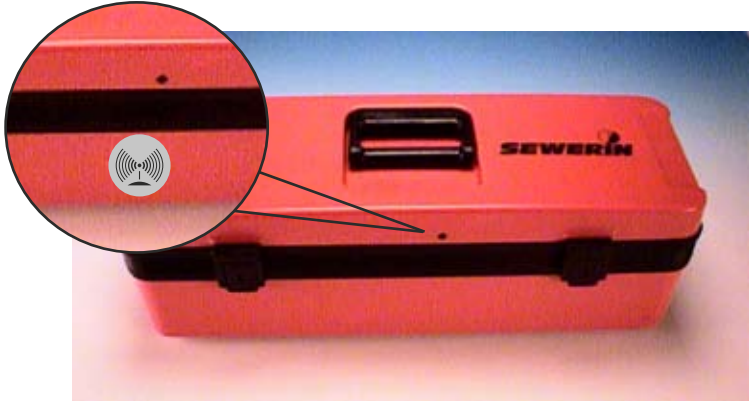

Picture 7: Generator G5 – Radio

3.4 AC/DC adapter L



The AC/DC adapter L is used to operate or charge the Generator G5. Comply with the minimum requirements listed in the technical data to ensure that the device operates correctly.

Picture 8: AC/DC adapter L



CAUTION!

When operating the device outdoors, ensure that the AC/DC adapter L is sufficiently protected against moisture. Otherwise, there is a risk of electric shock.

3.5 Car cable L

The car cable L is located in the carrying case in the compartment to the right of the generator (see Picture 1), below the AC/DC adapter L. It is used to supply the Generator G5 via the supplied AC/DC adapter L or a car battery.

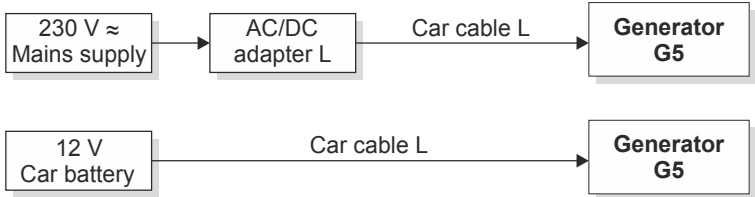

Picture 9: Connection to mains supply or car battery

**Note:**

Before connecting the cable to the AC/DC adapter L, unscrew the red adapter cap on the cable connector.

4 Knocker

The Knocker is located on the right-hand side of the carrying case. This device is an oscillator which places service pipes under oscillation. For more detailed information about pipe and leakage detection, refer to the operating instructions of the receiver (e.g., **AQUAPHON**).

The Knocker can be attached to pipes with a diameter up to 120 mm using the supplied chain attachment.



Picture 10: Knocker

4.1 **Knocker – Starting and operating**

Carry out the following steps to put the Knocker into operation.

1. Using the chain attachment, attach the Knocker to the pipe whose course is to be located.
2. Connect the Knocker to the Generator G5.
3. Switch on the Generator G5 using the ON/OFF switch (see Picture 3) on the generator's control panel.
4. Take the device you want to use for electroacoustic water leak detection (e.g., **AQUAPHON**), and put it into operation.
5. Use the adjuster on the Generator G5 to control the transmitted knock impulse. We recommend to rotate both adjusters to the central position, and then adjust the knock impulse to the local conditions.

4.2 **Working with the Knocker**

The following provides a few instructions and tips that will make your work with the Knocker easier.

Detection can be significantly influenced by the following factors:

- Ground surface
- Soil density
- Background noises

When adjusting the intensity of the impulse, take the local conditions into consideration.

After switchon, rotate both adjusters to the central position. Then adjust the impulse stepbystep until it suits the local conditions.

For detection in the close vicinity of the Knocker, we recommend that you do not select a too high frequency or intensity since, for example, house walls transmit the oscillations, thus making precise detection difficult.

4.3 Maintaining the Knocker



Note:

Repairs* to the device should be performed by SEWERIN Service or by a competent person. Rehabilitation* are to be carried out using only original SEWERIN spare parts.



CAUTION!

The connectors of the oscillator and the AC/DC adapter L are to be connected to the Generator G5 in a dry and clean state. Disregarding this can cause malfunctions and high wear and tear of the contacts.



Note:

If the inside of the case becomes damp, store the device with the case open. Rising damp can cause damage.

* According to DIN 31051:

- Servicing: Determining the actual state
- Maintenance: Measures for ensuring the shouldbe state
- Repairs: Measures for restoring the shouldbe state
- Rehabilitation: Servicing, maintenance and if necessary repairs

5 Stopper

The Stopper is a separate system component that is not stored in the carrying case (see Picture 2).

The Stopper creates a pressure wave by rapidly opening and closing the pipe. Main pipes (water) require more energy to be placed under oscillation. The water column is placed in motion by extracting water from a hydrant. A special shutoff element known as the Stopper slows down the motion of the water column at regular intervals. The resulting pressure waves propagate along the pipeline and can be detected over long distances. The intensity of the generated pressure wave can be adjusted via the valve on the device.



CAUTION!

If the set pressure waves are too large, damage to the pipeline can occur.

Always begin operation with the lowest intensity. Then increase the intensity as required stepbystep keeping the local conditions in mind.



Picture 11: Stopper, stand pipe, flushing adapter

5.1 Stopper – Starting and operating



Note:

Comply fully with the following instructions when starting and operating the Stopper. Note that Hermann Sewerin GmbH cannot be held liable for damage caused by non-compliance.

1. Connect the standpipe with the flushing adapter to the hydrant **under professional guidance**. Always flush out the hydrant and the pipeline to prevent contamination and foreign particles from collecting inside the device.
2. After flushing, close the shutoff valve, and remove the flushing adapter.
3. Connect the Stopper to the standpipe **under professional guidance**.
4. Connect the connection cable of the Stopper to the Generator G5 (Oscillator connection, see Picture 1).
5. Rotate the intensity adjuster (see Picture 13) fully clockwise, i.e., to the lowest intensity.



CAUTION!

Always begin operation with the lowest intensity. Then increase the intensity as required stepbystep keeping the local conditions in mind (e.g., state of the pipelines). The manometer on the standpipe indicates the actual pressure for monitoring purposes.

6. Open the shutoff valve on the standpipe, thus opening access to the Stopper.
7. Switch on the Generator G5 using the ON/OFF switch (see Picture 2) on the generator's control panel.
8. The device is now operating. Adjust the intensity carefully to suit the local conditions.
9. Take the device you want to use for electroacoustic water leak detection (e.g., **AQUAPHON**), and put it into operation.

5.2 Working with the Stopper

The following provides a few instructions and tips that will make your work with the Stopper easier.

Detection can be significantly influenced by the following factors:

- Ground surface
- Soil density
- Background noises

When adjusting the intensity of the impulse, take the local conditions into consideration.

Before switching on the Stopper, set the lowest intensity, and then carefully increase the intensity as required using the adjuster on the device.

For detection in the close vicinity of the Stopper, we recommend that you do not select a too high frequency or intensity since, for example, house walls transmit the oscillations, thus making precise detection difficult.

5.3 Maintaining the Stopper

Particles in the water can cause the plunger in the Stopper to jam. If this occurs, clean the plunger.

Proceed as follows to clean the Stopper:

Cleaning the Stopper plunger and cylinder:

1. Unscrew the socket head screws on the front of the Stopper using the supplied Allen key.
2. Withdraw the plunger and the electronics housing carefully out of the cylinder.
3. Flush out the plunger and cylinder thoroughly with water.
4. Feed the plunger carefully back into the cylinder. Ensure that the components do not cant.
5. Insert the socket head screws using the lock washers back into the Stopper.
6. Screw the socket head screws symmetrically tight.
7. Please observe the notes on use and care (section 5.4).

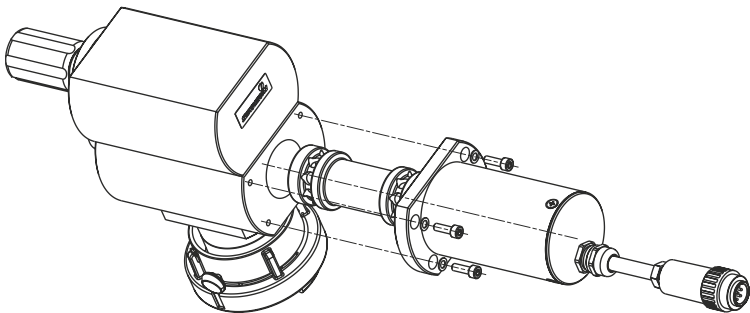

Picture 12: Stopper components

Cleaning the Stopper's intensity adjustment:

1. Unscrew the socket head screws on the front of the Stopper using the supplied Allen key.
2. Withdraw the valve carefully.
3. Withdraw the pusher carefully.
4. Flush out the valve, pusher and housing thoroughly with water.
5. Feed the pusher and valve carefully back into the housing. Ensure that the components do not cant.
6. Insert the socket head screws using the lock washers back into the Stopper.
7. Screw the socket head screws symmetrically tight.
8. Please observe the notes on use and care (section 5.4).

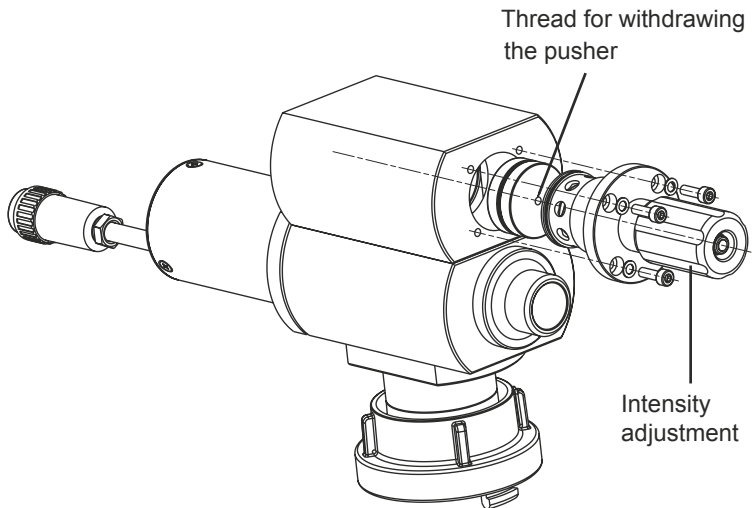

Picture 13: Stopper – cleaning the intensity adjustment

5.4 Important notes on use and care

The stopper is part of the COMBIPHON system. Even under normal operating conditions it is exposed to high mechanical loads and therefore subject to substantial wear and tear. The extent of wear is largely determined by the following factors:

- flow (intensity)
- frequency
- operating period (total hours)
- water quality

In particular, particles (e. g. lime) which have settled in the tube interior and which come off during operations reduce the service life of the Stopper.



NOTE:

A bellows for sealing purposes is in the casing. To prevent any damage to the stopper, have the bellows replaced at regular intervals by our service department.

Pay attention to the following notes on increasing the service life of the Stopper:

- The water flowing through the stopper may contain a considerable amount of dissolved lime which settles in the interior of the device during drying.

**Dismantle the Stopper after completing work (see section 5.3).
Flush the individual parts with lime-free or distilled water.**

- Due to wear and tear, the surfaces are prone to corrosion. Humidity enhances the rate of corrosion.

Dry all parts after use (or let them dry naturally).

Assemble the parts only when perfectly dry and/or only immediately before being used again.



CAUTION!

Water dripping from the vent on the underside of the casing indicates that the bellows inside is not seal-tight. Send the stopper **immediately** for repair to our service department. Only through professional dismantling by the department can further unrestricted corrosion and thus far-reaching sequential damage be stopped.

6 Troubleshooting

6.1 General

The oscillator generates no signal

Possible cause	Is the generator switched on?
Solution	Switch on the Generator G5 (turn ON/OFF switch clockwise).
Possible cause	Is the oscillator connected to the generator?
Solution	Check whether the oscillator's connection cable is connected to the generator.

The generator is switched on, but the LEDs are not lit

Possible cause	The generator's batteries are probably discharged. If the battery voltage falls below 10 V, the Generator G5 switches to "standby mode". Recharge the batteries.
-----------------------	--

6.2 Knocker

No signal can be detected

Possible cause	The impulse set on the generator is probably too weak.
Solution	Select a stronger impulse on the generator.
Possible cause	The Knocker's chain attachment has probably become so loose that the Knocker has slipped down.
Solution	Check the chain attachment, and retighten it as required.

6.3 Stopper

No signal can be detected

Possible cause The intensity set on the Stopper is probably too weak.

Solution Select a stronger intensity on the Stopper.

The stopper does not move

Possible cause

The plunger in the Stopper is jammed due to particles in the water.

Solution Clean the Stopper as described in section 5.3.

7 Technical data

7.1 Generator G5 and G5 Radio

AC/DC adapter L

Built-in lead accu	12 V/7.2 Ah
Optional power supply	Car battery 12 V (11 V – 14.5 V) AC/DC adapter L

Charging

Charging time	max. 9 hours
Charging temperature	0 °C – 40 °C

Operation

Protection class	Spray protection according to IP54 (without AC/DC adapter L)
Storage temperature	15 °C – +60 °C
Operating temperature	10 °C – +50 °C

Dimensions and weight

Width x Height x Depth	60 x 19 x 21 cm
Weight	7.63 kg (Generator G5, Knocker, AC/DC adapter L, car cable L)

7.2 AC/DC adapter L

Input	100 – 240 V~/ 50 Hz / 1 A
Output	12 V= / 3.8 A

7.3 Knocker

Max. operating time	80 hours
Min. operating time	4.5 hours

Control pulse

Knock period	16 ms to 80 ms (power)
Knock frequency	0.4 s ⁻¹ to 1.6 s ⁻¹ (central position = 1 s ⁻¹)

7.4 Stopper

Max. operating time	11 hours
Min. operating time	7.5 hours

Control pulse

Knock period	120 ms (not adjustable)
Knock frequency	1 s ⁻¹ to 1.6 s ⁻¹

7.5 Radio remote control (Option)

Range	30 m to 300 m
-------	---------------

Index

A

AC/DC adapter 1, 8, 9, 21
Acoustic leak detection 3

B

Battery LED 6

C

Car battery 9, 21
Car cable L 1, 9
Carrying case 5
Charging 21
Charging temperature 21
Charging time 21
COMBIPHON system 1, 5
Connection for an external power source 1
Connection for oscillator 1
Control elements of the generator 6
Control panel 6

D

Dimensions 21

G

Generator G5 1, 3, 6
Generator G5 radio 7
Generators G5 control panel 2

K

Knocker 1, 10 Knocker, operating 11 Knocker, starting 11

L

LED 2, 6
LED Battery 6
LED Booster 6
LED Knocker 6
LEDs are not lit 19
LED Stopper 6
Loading the Battery 7

M

Main pipes (water) 4, 13
Maintenance 12

N

No signal can be detected 19, 20

O

Operating temperature 21
Operating the Knocker 11
Operating the Stopper 14
Operation 21
Optional power supply 21

R

Remote control 1, 7

S

Service pipes (water or gas) 3
Softwareversion 23
Stopper 13
Stopper, operating 14 Stopper, starting 14 Stopper LED 6
Supplied chain attachment 10
System components 5 System Overview 1

T

Technical data 21
Troubleshooting 19

W

Weight 21
Working with the Knocker 11
Working with the Stopper 15